

Article number: 4395000421

Description: Rota-fix shaft-hub connection F42x75
Stainless steel

Measures

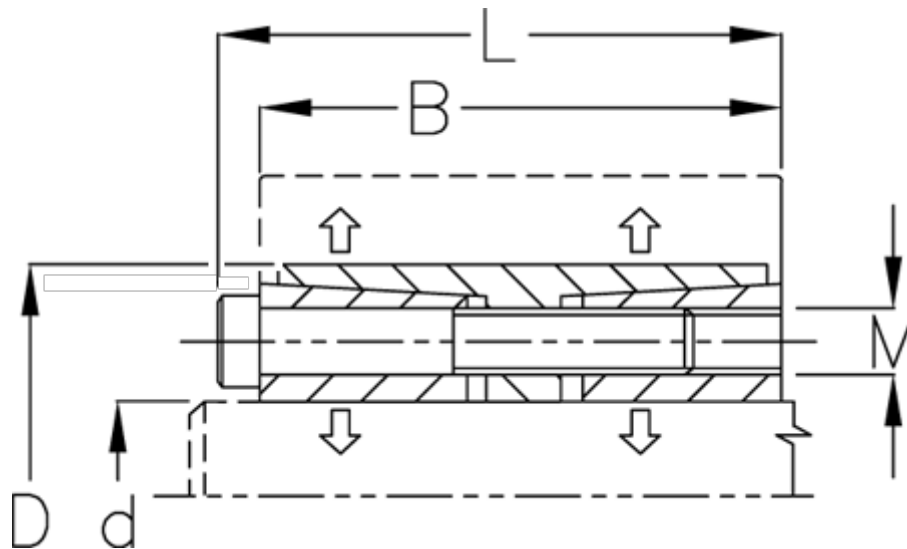

B mm	= 54
d H8 mm	= 42
D mm	= 75
Fit tolerance	= Aksel h8, Nav H8
F kN torque	= 76.7
L mm	= 62
M mm	= M8
P N/mm ² surface pressure on shaft/hub	= 38

Surface roughness	= R ? ? 3.2 μm
T N m torque	= 1610
Ts N m bolt tightening torque	= 28.7